

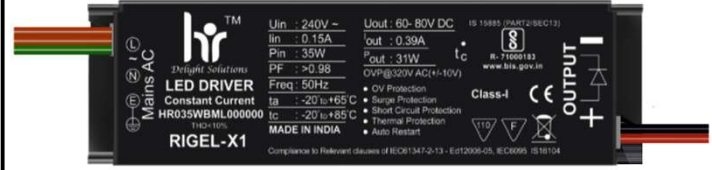

PRODUCT DESCRIPTION

- Fixed output build in LED Driver.
- Constant Current LED Driver.
- Nominal Life-Time Upto 50,000 Hrs.
- 3/5-Years Warranty.
- High Voltage withstanding capacity 440V AC.
- CE (Certified).
- IS 15885 (Part 2/Sec 13).
- IS 16104.
- IEC 60950-1.
- IEC 61000-4-5.



Input Characteristics

1	Voltage (Un)	240 Vac
2	Operating Voltage Range	100 ~300 Vac
3	Frequency (Hz)	50 / 60 Hz
4	Maximum Input Current	0.17A
5	Input Power (W)	40W
6	Power Factor (PF)	> 0.98
7	Inrush current Protection	Yes
8	Current Harmonics (Athd)	< 10%
9	Surge Withstanding Capacity	4KV
10	Over Voltage Cutoff	310V (Tole +/-10V)
11	Under Voltage Cutoff	110V
12	Automatic Restart	300V
13	Driver Life	>50000Hrs

Output Characteristics

Output short circuit protection and Restart	Yes
Thermal Protection	Yes
No-Load Protection	Yes
Max Output Current	1000mA (Tole +/-3%)
Output Voltage	25-36V
Output Power (W)	36W max
Efficiency	85%

Environmental Operating Details

1	Minimum Starting Temperature	-30°C ... 75°C
2	Max. Ambient Temperature	-20°C ... to 65°C
3	Max. Case temperature (Tc)	85°C

Key Features

- Compact Design
- High Voltage withstanding capacity
- High Surge withstanding capacity
- Long Life
- High Durability
- Automatic Restart after Safe Voltage Mode.

METAL BOX

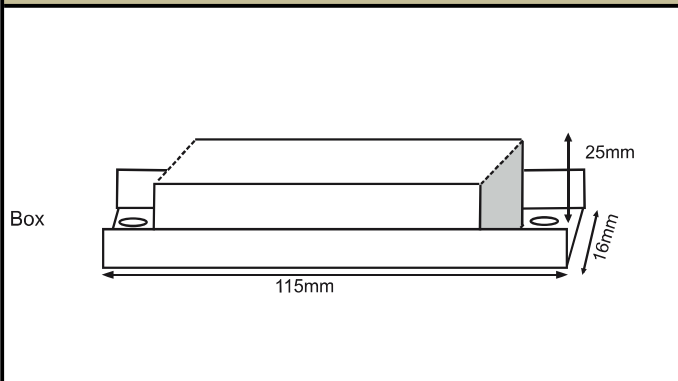

Mechanical Details

1	Weight	220gm.
2	Case Dimensions	
	Length	124mm
	Center to Center (CTC)	113mm
	Width	36mm
	Height	27mm
3	Case Material	Metal Box
4	Wiring Diagram	On Screen
5	Input / Output Terminals	WIRE
6	Wires Length & Colors	
	Input (White)	300mm
	Output (Red & Black)	300mm
7	Potting	IP20 & IP65

BOTTOM

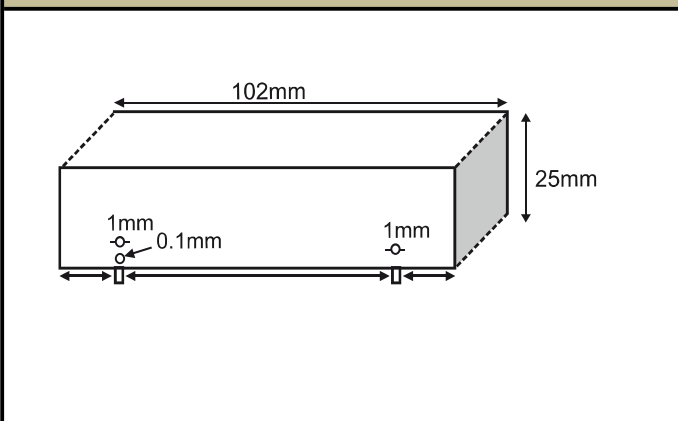

TOP

