

PRODUCT DESCRIPTION

- Fixed output build in LED Driver.
- Constant Current LED Driver.
- Nominal Life-Time Upto 30,000 hr.
- 3 Year Warranty.
- CE (Certified).
- IS 15885 (Part 2/Sec 13).
- IS 16104.
- IEC 60950-1.
- IEC 61000-4-5.



Input Characteristics

1	Voltage (Un)	240 Vac
2	Operating Voltage Range	100 ~300 Vac
3	Frequency (Hz)	50 / 60 Hz
4	Maximum Input Current	0.06A
5	Input Power (W)	14W
6	Power Factor (PF)	> 0.95
7	Inrush current Protection	Yes
8	Current Harmonics (Athd)	< 20%
9	Surge Withstanding Capacity	4 KV
10	Over Voltage Cutoff	375V (Tole - +/-10V)
11	Automatic Restart	320V
12	Driver Life	>30000Hrs

Product images are for reference only,Screen image change with respect to product specification.

Output Characteristics

Output short circuit protection and Restart	Yes
Thermal Protection	Yes
No-Load Protection	Yes
Max Output Current	300mA (Tole - +/-3%)
Output Voltage	25-40V
Output Power (W)	12W max
Efficiency	>85%

Environmental Operating Details

1	Minimum Starting Temperature	-30°C ... 85°C
2	Max. Ambient Temperature	-20°C ... to 50°C
3	Max. Case temperature (Tc)	75°C

Key Features

- Compact Design
- High Voltage withstanding capacity
- High Surge withstanding capacity
- Long Life
- High Durability
- Automatic Restart after Safe Voltage Mode.

PLASTIC BOX

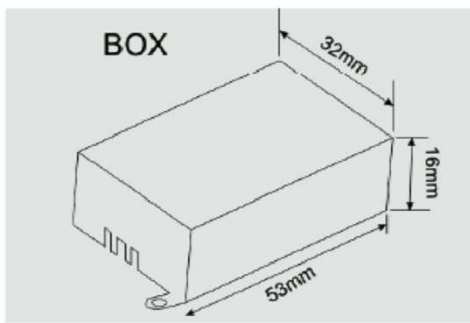

Mechanical Details

1	Weight	90 gm
2	Case Dimensions	
	Length W/Mounting Hole	55mm
	Length With/Mounting Hole	61
	Width	35mm
	Height	17mm
3	Case Material	ABS
4	Wiring Diagram	On Screen
5	Input / Output Terminals	Wire
6	Wires Length & Colors	
	Input (Yellow)	NA
	Output (Red & Black)	NA
7	Potting	NA

BOTTOM

