

PRODUCT DESCRIPTION

- Fixed output build in LED Driver.
- Constant Current LED Driver.
- Nominal Life-Time Upto 30,000 hr.
- 3/5-Years Warranty.
- High Voltage withstanding capacity 440V AC.
- CE (Certified).
- IS 15885 (Part 2/Sec 13).
- IS 16104.
- IEC 60950-1.
- IEC 61000-4-5.

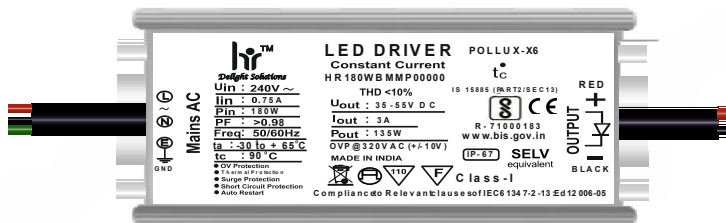

Input Characteristics

1	Voltage (Un)	240 Vac
2	Operating Voltage Range	100 ~300 Vac
3	Frequency (Hz)	50 / 60 Hz
4	Maximum Input Current	0.65A
5	Input Power (W)	155W
6	Power Factor (PF)	> 0.98
7	Inrush current Protection	Yes
8	Current Harmonics (Athd)	< 10%
9	Surge Withstanding Capacity	6 KV
10	Over Voltage Cutoff	320V (Tole : +/-10V)
11	Under Voltage Cutoff	110V
12	Automatic Restart	300V
13	Driver Life	>30000Hrs

Output Characteristics

Output short circuit protection and Restart	Yes
Thermal Protection	Yes
No-Load Protection	Yes
Max Output Current	2300MA (Tole : +/-3%)
Output Voltage	40-60V
Output Power (W)	140W max
Efficiency	90%

Environmental Operating Details

1	Minimum Starting Temperature	-30°C ... 75°C
2	Max. Ambient Temperature	-20°C ... to 65°C
3	Max. Case temperature (Tc)	85°C

Key Features

- Compact Design
- High Voltage withstanding capacity
- High Surge withstanding capacity
- Long Life
- High Durability
- Automatic Restart after Safe Voltage Mode.

Aluminium Box

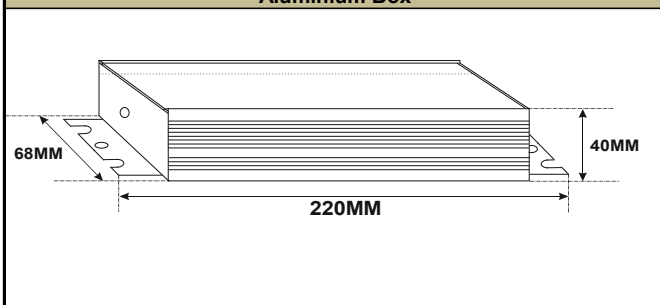

Mechanical Details

1) Weight	750gm
2) Case Dimensions	
Length W/Mount	220mm
Center to Center (CTC)	208mm
Width	68mm
Height	40mm
3 Case Material	Aluminium
4 Wiring Diagram	On Screen
5 Input / Output Terminals	NA
6 Wires Length	
Input (3 Core or single core- White(L,N) & Green-E)	300mm
Output (Single Core Wire- Red(+),Black(-)	300mm
7 IP65/IP20	YES

Bottom

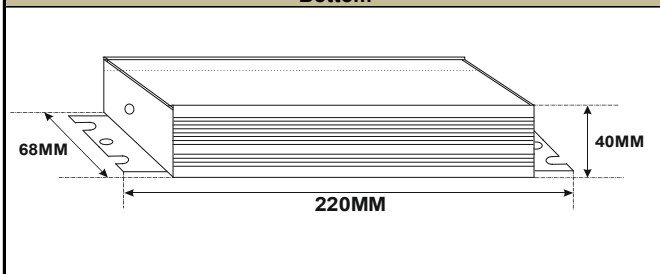

Top

